

ELYS.

The
essence
of light.



The essence of light.

 elysight.com

 [ELYS.light](https://www.instagram.com/ELYS.light)



ELYS - The essence of light

Introduction.

ELYS. - THE ESSENCE OF LIGHT

As an architectural lighting designer, you know how to make a big impact on the atmosphere of any space. Meanwhile, you have to navigate within the set boundaries of a project; the vision of the (interior) architect, the function of the building, sustainability goals and of course: the budget. It almost seems impossible to meet all requirements.

With Elys you don't have to compromise. You can have both quality and design while staying within your budget. Elys is here to tie it all together.

Our story.

Premium design

The refined design of the Elys portfolio gives every space a high-end finishing touch. The range of different sizes, materials, finishes and colours allow you to perfectly match the style of each space.

Optimal light quality

Elys uses LED chips of only the best quality. Its unique LumiCross Lens Technology offers a low glare. And with a standard Colour Rendering Index of >98Ra, colours will look exactly like the architect envisioned.

No compromising

At Elys, you can get all of the above without having to break the bank. Great quality, design and flexibility, within an affordable price range.



ELYS.

The
essence
of light.



Our vision.

MADE IN HOLLAND

We're lighting manufacturers with a strong grasp of both design and technical aspects. What sets us apart is our ability to blend the right luminaire, LED module, light output, colour, and focal point seamlessly. With all the expertise and craftsmanship under one roof, we specialize in turning ideas into unique luminaires. Every ELYS. luminaire is assembled in the Netherlands, allowing us to maintain control over the production, ensuring flexibility and a commitment to high quality and craftsmanship.

MODULAR & CIRCULAR

As well as being aware of its environmental impact, ELYS. is at the forefront of environmentally friendly production of its high quality luminaires. The use of alternative energy sources and the recycling of raw materials is a matter of course. ELYS. focuses on prolonging the life of the product, optimising efficiency and the modular design, which makes it possible to create a completely new look with an existing module by simply replacing the front ring with a different colour or model. You can easily switch the housing. A broken component? Keep the housing and replace only the broken part.





Index.

Recessed luminaires	12
Eterna12.	14
Eterna18.	26
Altera SR.	34
Track luminaires	38
Altera TR.	40
Altera 48V.	42
Wall luminaires	44
Eterna WL.	46
Ombra.	48
Surface mounted luminaires	52
Eterna SF.	54
Altera SF.	56
Pendant luminaires	58
Eterna PD.	60



Recessed luminaires.

Introducing the Recessed luminaires, a versatile range of architectural recessed spotlights available in variety of sizes and finishes.

With options for both curved and flat front ring designs, the Recessed luminaires caters to diverse aesthetic preferences while maintaining sleek lines and subtle finishes.

Equipped with unique LumiCross Lens technology, these spotlights ensure minimal glare and maximum visual comfort. Crafted with precision engineering, they seamlessly integrate into any space, combining style and practicality effortlessly.

Illuminate your environment, where innovation meets versatility to redefine your lighting experience.



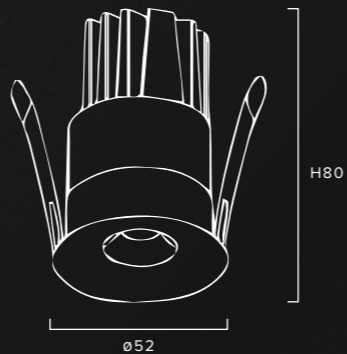

Eterna12.

CURVED RECESSED

Recessed luminaire distinguished by its sleek curved lines and remarkable compactness with an outer diameter of just 52mm. Designed with precision for optimal functionality and elegance in lighting design. The advanced LumiCross Lens technology minimizes glare while providing exceptional visual comfort.

Illumination options

CCT 2200K • CRI >90Ra • 400Lm
 CCT 2700K • CRI >98Ra • 750Lm
 CCT 3000K • CRI >98Ra • 790Lm

UGR

<13 for 24° • <17 for 36°

Cut out size

Ø48 x H85mm

LIGHT BEAM ANGLE



FIXTURE OPTIONS



Available Finishes

Standard

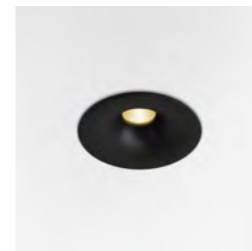

Black

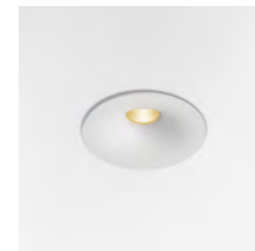

White

Premium

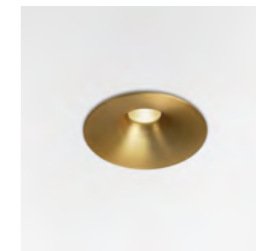

Matte brass

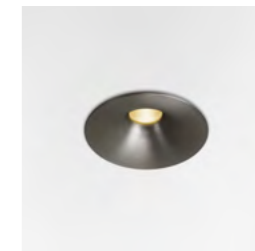

Gunmetal

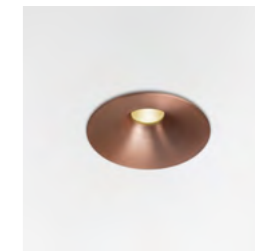

Matte copper

Custom RAL colours

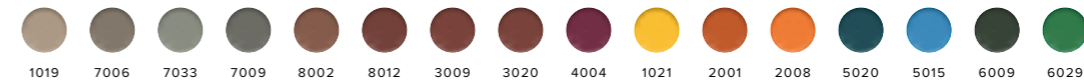

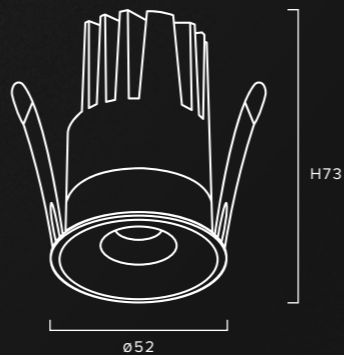

Eterna12.

POINT RECESSED

Recessed luminaire featuring a flat front ring design; this spotlight creates a subtle pinpoint of light with an outer diameter of just 52mm. Crafted with precision for seamless integration into every interior design. The advanced LumiCross Lens technology minimizes glare while providing exceptional visual comfort.

Illumination options

CCT 2200K • CRI >90Ra • 400Lm
 CCT 2700K • CRI >98Ra • 750Lm
 CCT 3000K • CRI >98Ra • 790Lm

UGR

<18 for 24° • <24 for 36°

Cut out size

Ø48 x H78mm

LIGHT BEAM ANGLE



24° LENS

36° LENS

FIXTURE OPTIONS



Available Finishes

Standard

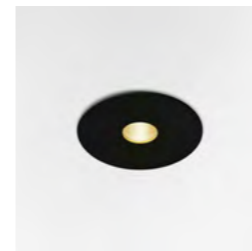

Black



White

Premium

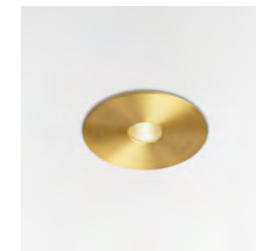

Matte brass

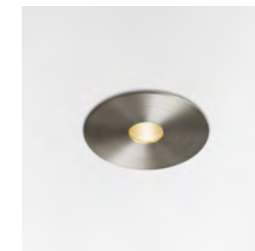

Gunmetal

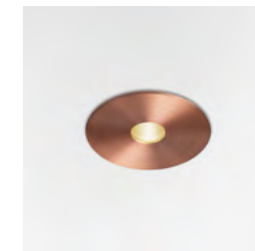

Matte copper

Custom RAL colours



1019 7006 7033 7009 8002 8012 3009 3020 4004 1021 2001 2008 5020 5015 6009 6029

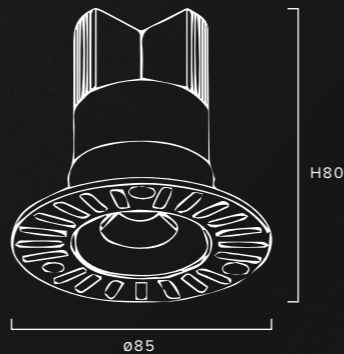
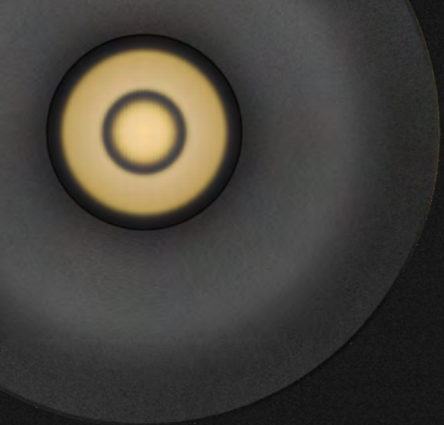

Eterna12.

CURVED TRIMLESS

Trimless luminaire with curved front ring design; offers a unique and elegant integration in your ceiling that blends perfectly with any interior. The advanced LumiCross Lens technology minimizes glare while providing exceptional visual comfort.

Illumination options

CCT 2200K • CRI >90Ra • 400Lm
 CCT 2700K • CRI >98Ra • 750Lm
 CCT 3000K • CRI >98Ra • 790Lm

UGR

<13 for 24° • <17 for 36°

Cut out size

Ø54 x H85mm

LIGHT BEAM ANGLE



FIXTURE OPTIONS



Available Finishes

Standard

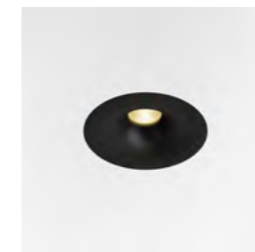

Black



White

Premium

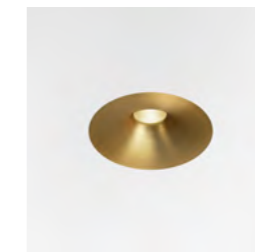

Matte brass

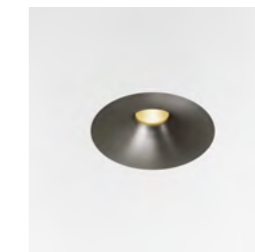

Gunmetal

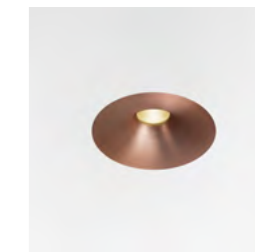

Matte copper

Custom RAL finishes



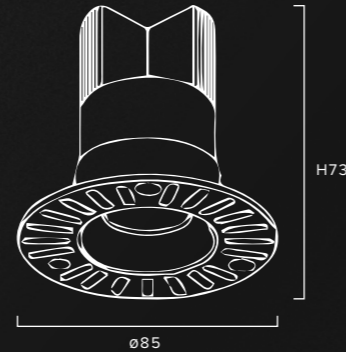

Eterna12.

POINT TRIMLESS

Trimless luminaire with flat front ring design offers a perfect alignment into your ceiling, ensuring modern aesthetics. The advanced LumiCross Lens technology minimizes glare while providing exceptional visual comfort.

Illumination options

CCT 2200K • CRI >90Ra • 400Lm
 CCT 2700K • CRI >98Ra • 750Lm
 CCT 3000K • CRI >98Ra • 790Lm

UGR

<18 for 24° • <24 for 36°

Cut out size

Ø54 x H78mm

LIGHT BEAM ANGLE



FIXTURE OPTIONS



Available Finishes

Standard



Black

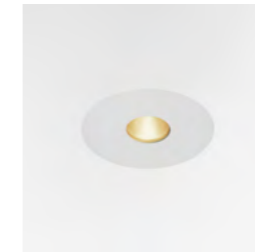

White

Premium

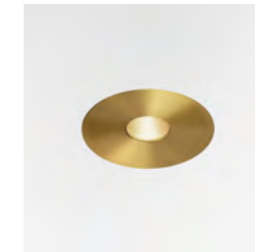

Matte brass

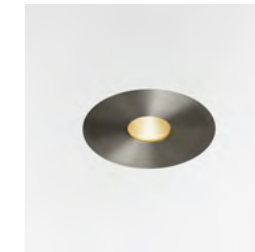

Gunmetal

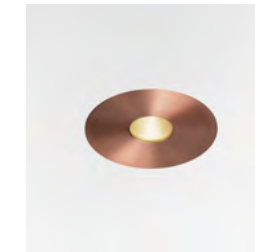

Matte copper

Custom RAL finishes

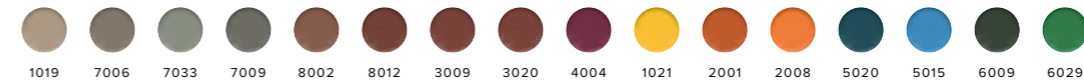

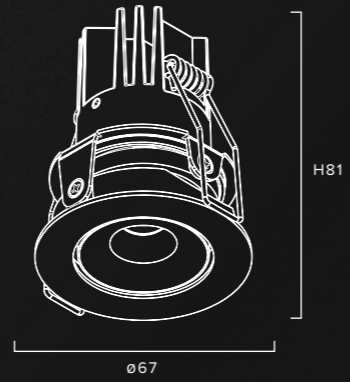

Eterna12 ADJ.

CURVED RECESSED

Recessed luminaire featuring a uniquely designed adjustable front ring. Perfect for directing light to highlight specific objects or areas. Utilizing the advanced LumiCross Lens technology for minimal glare combined with exceptional visual comfort

Illumination options

CCT 2200K • CRI >90Ra • 400Lm
 CCT 2700K • CRI >98Ra • 750Lm
 CCT 3000K • CRI >98Ra • 790Lm

UGR

<13 for 24° • <17 for 36°

Cut out size

Ø62 x H120mm

LIGHT BEAM ANGLE



FIXTURE OPTIONS

STANDARD	TRIAC	DALI	CASAMBI	TW	HONEYCOMB	SQUARE FRAME	IP44
DIMMABLE		DIMMABLE					

Available Finishes

Standard



Black



White

Premium

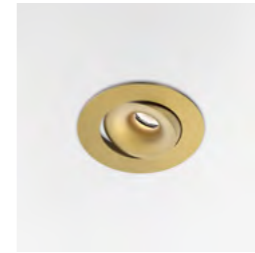

Matte brass



Gunmetal



Matte copper

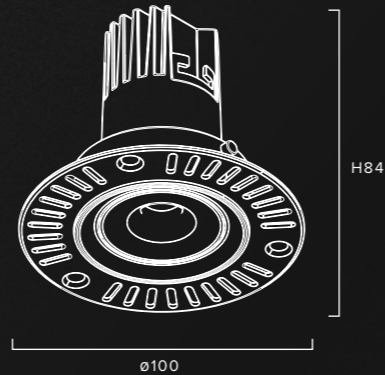

Eterna12 ADJ.

CURVED TRIMLESS

Trimless luminaire featuring a uniquely designed adjustable front ring. Perfect for directing light to highlight specific objects or areas. Utilizing the advanced LumiCross Lens technology for minimal glare combined with exceptional visual comfort

Illumination options

CCT 2200K • CRI >90Ra • 400Lm
 CCT 2700K • CRI >98Ra • 750Lm
 CCT 3000K • CRI >98Ra • 790Lm

UGR

<13 for 24° • <17 for 36°

Cut out size

Ø68 x H120mm

LIGHT BEAM ANGLE



24° LENS 36° LENS

FIXTURE OPTIONS



Available Finishes

Standard



Black



White

Premium

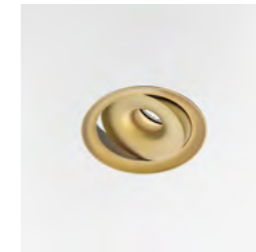

Matte brass



Gunmetal

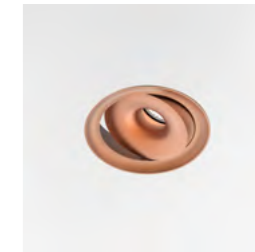

Matte copper

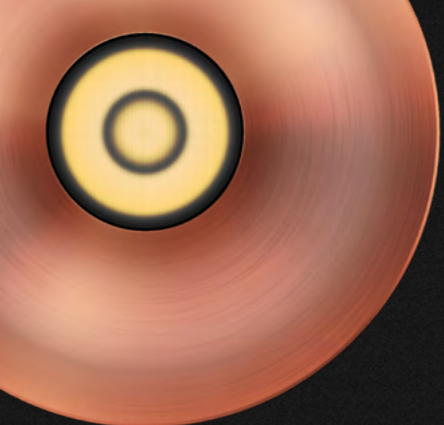

Eterna18.

CURVED RECESSED

Trimless luminaire distinguished by its sleek curved lines and a larger outer diameter of 62mm for better illumination. Designed with precision for optimal functionality and elegance in lighting design. The advanced LumiCross Lens technology minimizes glare while providing exceptional visual comfort.

Illumination options

CCT 2200K • CRI >90Ra • 550Lm
 CCT 2700K • CRI >98Ra • 970Lm
 CCT 3000K • CRI >98Ra • 1050Lm

UGR

<11 for 24° • <16 for 36°

Cut out size

Ø58 x H105mm

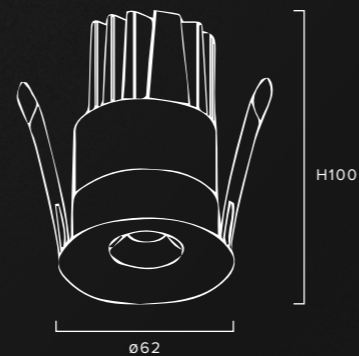

LIGHT BEAM ANGLE



FIXTURE OPTIONS



Available Finishes

Standard

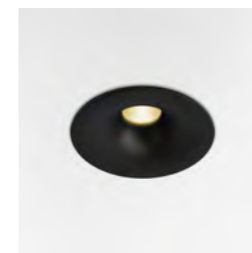

Black



White

Premium

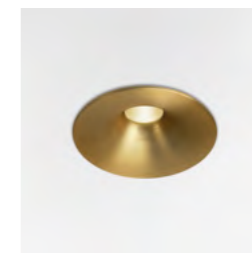

Matte brass

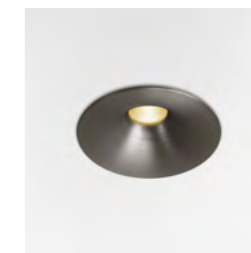

Gunmetal

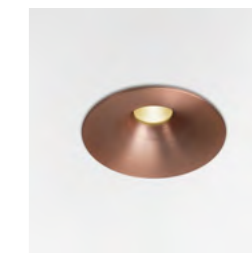

Matte copper

Custom RAL finishes





Eterna18.

POINT RECESSED

Recessed luminaire featuring a flat front ring design, this spotlight creates a pinpoint of light with an larger outer diameter of 62mm. Crafted with precision for seamless integration into every interior design. The advanced LumiCross Lens technology minimizes glare while providing exceptional visual comfort.

Illumination options

CCT 2200K • CRI >90Ra • 550Lm
 CCT 2700K • CRI >98Ra • 970Lm
 CCT 3000K • CRI >98Ra • 1050Lm

UGR

<18 for 24° • <25 for 36°

Cut out size

Ø58 x H95mm

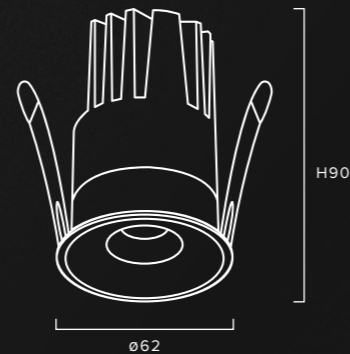

LIGHT BEAM ANGLE



FIXTURE OPTIONS

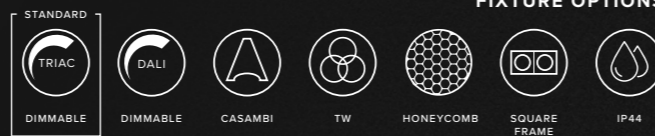

Available Finishes

Standard



Black



White

Premium

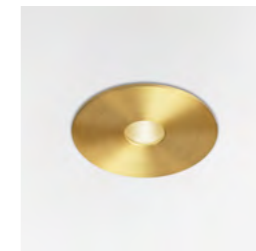

Matte brass

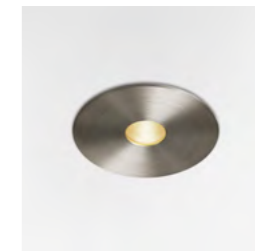

Gunmetal

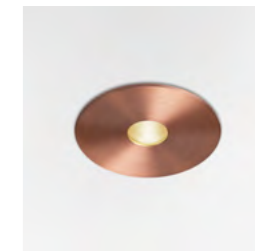

Matte copper

Custom RAL finishes



1019 7006 7033 7009 8002 8012 3009 3020 4004 1021 2001 2008 5020 5015 6009 6029

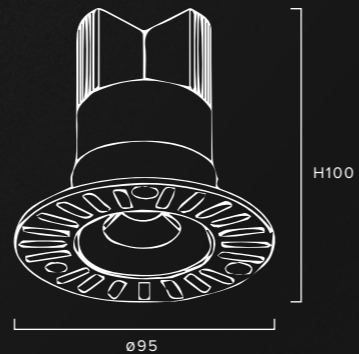

Eterna18.

CURVED TRIMLESS

Trimless luminaire with curved front ring design offers a unique and elegant integration in your ceiling that blends perfectly with any interior. The advanced LumiCross Lens technology minimizes glare while providing exceptional visual comfort.

Illumination options

CCT 2200K • CRI >90Ra • 550Lm
 CCT 2700K • CRI >98Ra • 970Lm
 CCT 3000K • CRI >98Ra • 1050Lm

UGR

<11 for 24° • <16 for 36°

Cut out size

Ø64 x H105mm

LIGHT BEAM ANGLE



FIXTURE OPTIONS

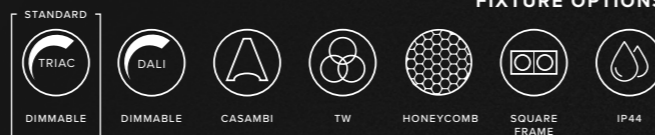

Available Finishes

Standard



Black



White

Premium

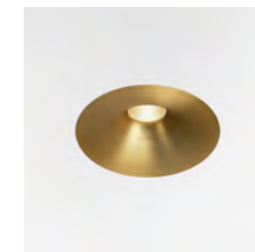

Matte brass



Gunmetal

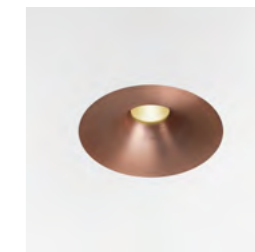

Matte copper

Custom RAL finishes

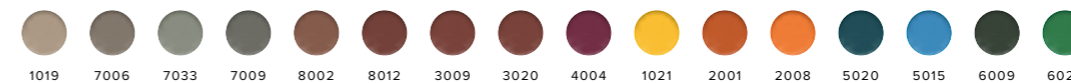

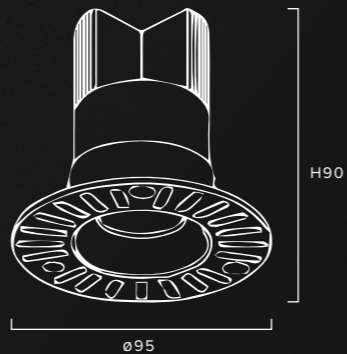

Eterna18.

POINT TRIMLESS

Recessed luminaire featuring a flat front ring design, this spotlight creates a pinpoint of light with an larger outer diameter of 62mm. Crafted with precision for seamless integration into every interior design. The advanced LumiCross Lens technology minimizes glare while providing exceptional visual comfort.

Illumination options

CCT 2200K • CRI >90Ra • 550Lm
 CCT 2700K • CRI >98Ra • 970Lm
 CCT 3000K • CRI >98Ra • 1050Lm

UGR

<18 for 24° • <25 for 36°

Cut out size

Ø64 x H95mm

LIGHT BEAM ANGLE



24° LENS 36° LENS

FIXTURE OPTIONS



Available Finishes

Standard



Black

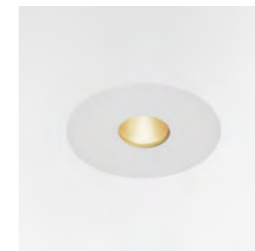

White

Premium

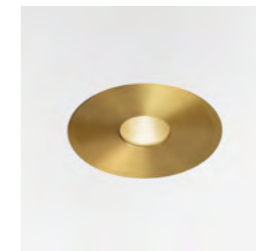

Matte brass

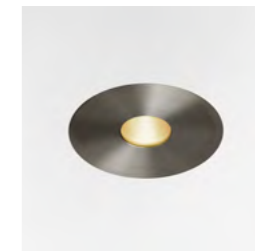

Gunmetal

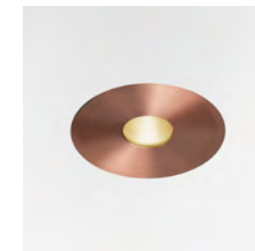

Matte copper

Custom RAL finishes



1019 7006 7033 7009 8002 8012 3009 3020 4004 1021 2001 2008 5020 5015 6009 6029



Eterna18 RZ.

CURVED RECESSED

Recessed luminaire featuring a raised-edge front ring design, this spotlight creates a bold but stylish design with a larger outer diameter of 62mm and protrudes 10mm from the ceiling. It delivers focused, precise lighting while adding an architectural touch to ceilings. The advanced LumiCross Lens technology minimizes glare and ensures exceptional visual comfort.

Illumination options

CCT 2200K • CRI >90Ra • 550Lm
 CCT 2700K • CRI >98Ra • 970Lm
 CCT 3000K • CRI >98Ra • 1050Lm

UGR

<11 for 24° • <16 for 36°

Cut out size

Ø58 x H95mm

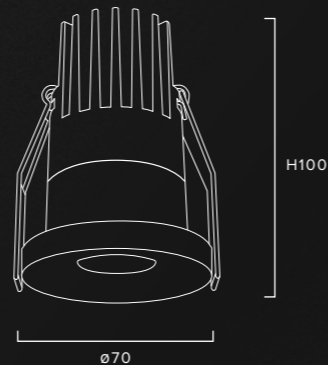

LIGHT BEAM ANGLE



24° LENS 36° LENS

FIXTURE OPTIONS



Available Finishes

Standard



Black



White

Premium

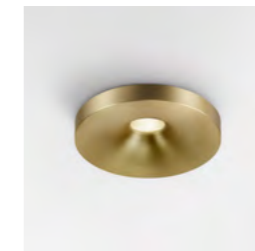

Matte brass



Gunmetal



Matte copper

Custom RAL finishes

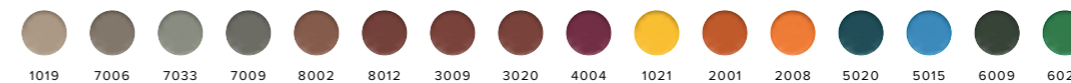

1019 7006 7033 7009 8002 8012 3009 3020 4004 1021 2001 2008 5020 5015 6009 6029

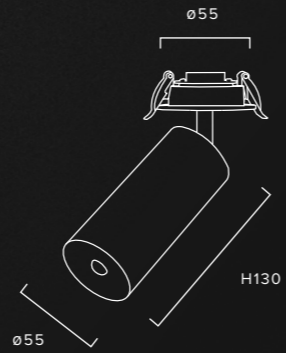
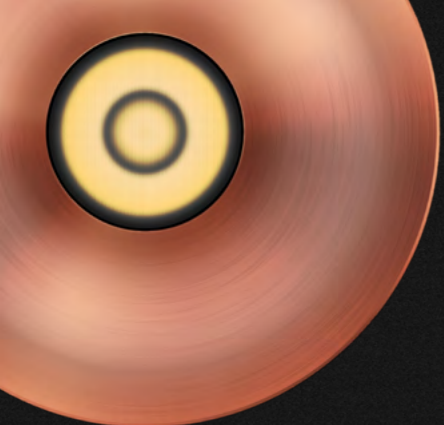

Altera SR.

Semi-recessed luminaire with sleek curved lines, designed for partial ceiling integration. Offering an adjustable design for precise beam positioning to create the ideal ambiance in any décor. Utilizing the advanced LumiCross Lens technology, it delivers exceptional illumination with minimal glare and maximum visual comfort.

Illumination options CCT 2700K • CRI >98Ra • 800Lm
 CCT 3000K • CRI >98Ra • 850Lm

UGR <18 for 24° • <25 for 36°

Cut out size Ø45 x H45mm

LIGHT BEAM ANGLE



FIXTURE OPTIONS



Available Finishes

Standard



Black



White

Premium



Matte brass



Gunmetal



Matte copper

Custom RAL finishes



1019 7006 7033 7009 8002 8012 3009 3020 4004 1021 2001 2008 5020 5015 6009 6029

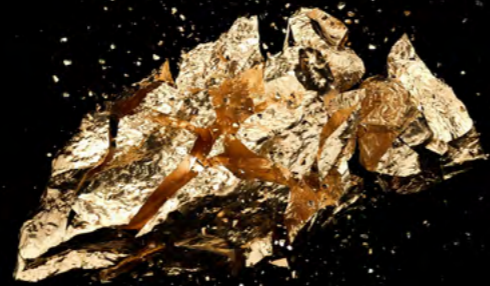

The essence of detail.

At ELYS, we believe that true elegance lies in the details. Every fixture we create embodies our commitment to pure craftsmanship, blending the finest materials into a timeless design to illuminate your space with refinement.

Our dedication to quality begins with the selection of materials. We source only the best materials to ensure our luminaires are crafted from premium metals, ensuring that every component is selected for its durability and aesthetic appeal.

Regardless of which finish you choose, every ELYS fixture represents pure Dutch craftsmanship with precision and attention to detail. From the initial design to the final inspection, each step in the process is carried out with meticulous care from our manufacturing office in The Netherlands. Ensuring that each product is assembled to uphold the highest standards.



ELYS - The essence of light



Track luminaires.

Introducing the Track luminaires, designed for versatility and precision. These sleek, cylindrical fixtures feature an elegant housing, offering a clean and modern look. Ideal for both residential and commercial spaces, they provide flexible light direction, perfect for highlighting areas or focused task lighting. With their high-quality build and contemporary design, they effortlessly blend into any setting, combining functionality with style. A perfect choice for any modern lighting scheme.



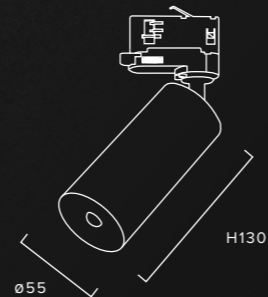

Altera TR.

Luminaire with sleek curved lines designed for 1-circuit and 3-circuit track systems, offering both elegance and functionality. Its adjustable adapter allows for precise beam positioning, for crafting the perfect ambiance in any décor. Enhanced by advanced LumiCross Lens technology, this luminaire delivers high-quality illumination with minimal glare and optimized visual comfort.

Illumination options

CCT 2700K • CRI >98Ra • 800Lm
 CCT 3000K • CRI >98Ra • 950Lm

UGR

<13 for 24° • <17 for 36°

LIGHT BEAM ANGLE



FIXTURE OPTIONS



Available Finishes

Standard



Black



White

Premium



Matte brass



Gunmetal



Matte copper

Custom RAL finishes



1019 7006 7033 7009 8002 8012 3009 3020 4004 1021 2001 2008 5020 5015 6009 6029

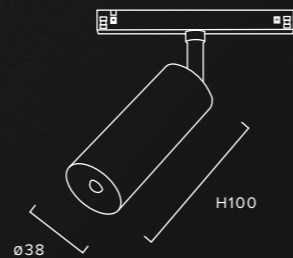

Altera 48V.

Luminaire designed specifically for the Powergear 48V track system. It combines sleek curved lines with a compact form factor. Its adjustable adapter allows for precise beam control while maintaining a minimalistic appearance. Utilizing advanced LumiCross Lens technology, this luminaire delivers outstanding illumination with minimal glare and exceptional visual comfort, making it an ideal solution for spaces where compactness and efficiency are key.

Illumination options CCT 2700K • CRI >98Ra • 600Lm
CCT 3000K • CRI >98Ra • 650Lm

UGR <13 for 24° • <17 for 36°

LIGHT BEAM ANGLE



FIXTURE OPTIONS

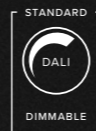

Available Finishes

Standard



Black



White

Premium



Matte brass



Gunmetal



Matte copper

Custom RAL finishes

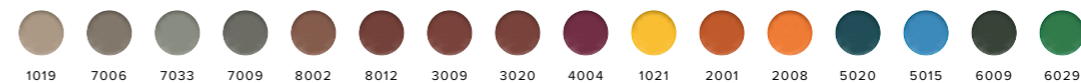

1019 7006 7033 7009 8002 8012 3009 3020 4004 1021 2001 2008 5020 5015 6009 6029

Wall luminaires.

Introducing the Wall luminaires, designed to elevate and complete any project. This range offers a variety of styles, from sleek up-down fixtures that highlight architectural features to soft, rounded designs that bring a warm and inviting glow to any space. Ideal for creating eye-catching wall compositions, each luminaire combines high-quality materials with functional design, ensuring both aesthetic appeal and practicality.

Whether you're looking to add bold accent lighting or subtle ambient illumination, our collection provides the perfect solutions to enhance the environment with a touch of sophistication.



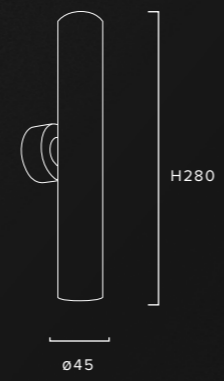
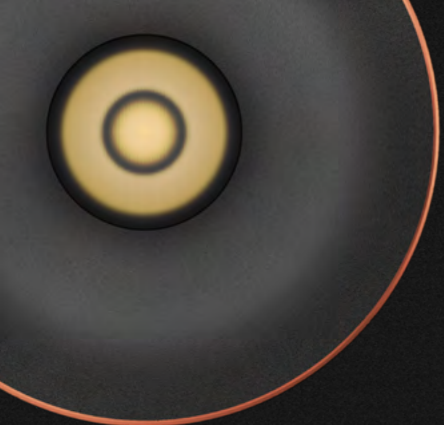

Eterna WL.

Sleek tubular surface mounted luminaire for wall mounting. Offering bi-directional lighting; emitting a warm glow both upwards and downwards, creating an inviting atmosphere in any space. Its minimalist design with 30-degree rotatable wall mount ensures precise light positioning.

Illumination options CCT 2700K • CRI >90Ra • 2x 400Lm
CCT 3000K • CRI >90Ra • 2x 400Lm

UGR <10 for 24° • <14 for 36°

LIGHT BEAM ANGLE



FIXTURE OPTIONS



Available Finishes

Standard



Black



White

Premium



Matte brass



Gunmetal



Matte copper

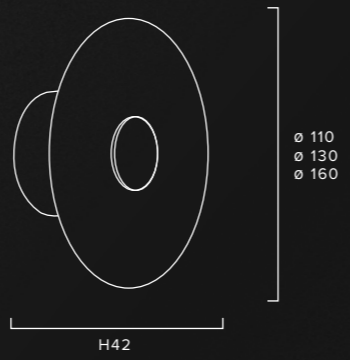

Ombra.

Versatile surface mounted luminaire designed for wall mounting. Features a two-part design with interchangeable components, enabling you to create customizable finish combinations that seamlessly align with your interior design. The indirect lighting enhances the ambiance with a soft, diffused glow, creating a warm and inviting atmosphere. Available in two sizes.

Illumination options CCT 2700K • CRI >90Ra • 300Lm
CCT 3000K • CRI >90Ra • 350Lm

Available sizes Ø110mm • Ø130mm • Ø160mm

FIXTURE OPTIONS

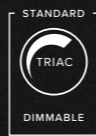

Available Finishes

Standard

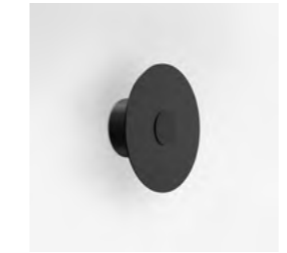

Black



White

Premium



Matte brass



Gunmetal



Matte copper

Custom RAL finishes



LumiCross Lens Technology.

ELYS. utilizes a special lens technology that emits light in a cross-linked pattern. This unique feature allows us to design our luminaires with very small openings and minimal light loss. An important additional advantage is the very low Unified Glare Rating (UGR), which ensures that the light is perceived as highly comfortable, seamlessly blending the luminaire into the surrounding space.

With ELYS., you not only experience efficient lighting but also enjoy enhanced comfort and aesthetics, making your environment more inviting and pleasant.

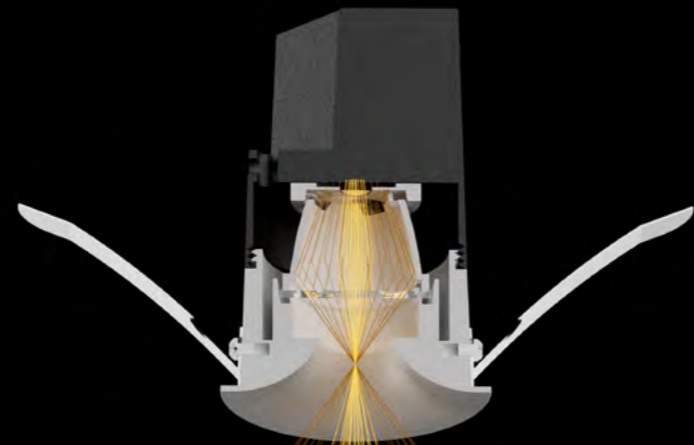

ELYS - The essence of light

Surface mounted luminaires.

Introducing the Surface Mounted Luminaires, a versatile addition to the Eterna and Altera family, offering the same elegance and functionality in a convenient surface-mounted version. Crafted with precision engineering, these fixtures features the sleek curved lines and subtle finishes that define the Curved series.

With its unique seamless design, the Surface Mounted Luminaires brings sophistication to any space, providing exceptional illumination while integrating into any environment. Experience the perfect balance of style and practicality with the Eterna Surface, where innovation meets convenience in lighting design.



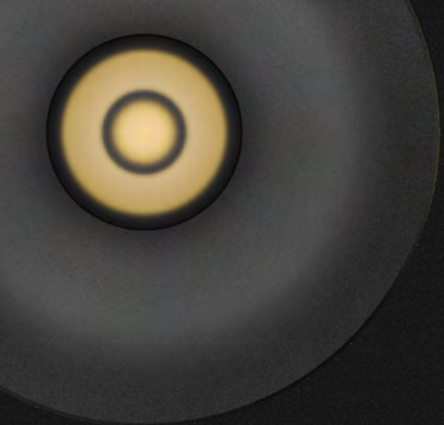

Eterna SF.

Surface mounted luminaire featuring sleek curved lines offering elegance and functionality in one compact design. Crafted from a single piece, featuring an internal driver and invisible mounting design for seamless integration. The advanced LumiCross Lens technology minimizes glare while providing exceptional visual comfort.

Illumination options CCT 2700K • CRI >98Ra • 800Lm
CCT 3000K • CRI >98Ra • 900Lm

UGR <12 for 24° • <15 for 36°

LIGHT BEAM ANGLE



FIXTURE OPTIONS

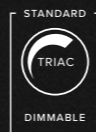

Available Finishes

Standard



Black



White

Premium



Matte brass



Gunmetal



Matte copper

Custom RAL finishes

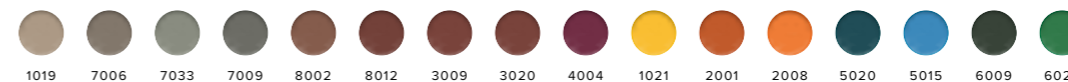

1019 7006 7033 7009 8002 8012 3009 3020 4004 1021 2001 2008 5020 5015 6009 6029

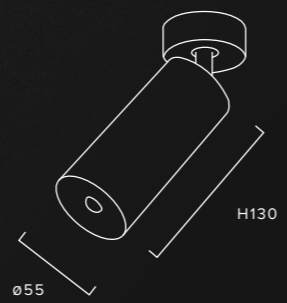
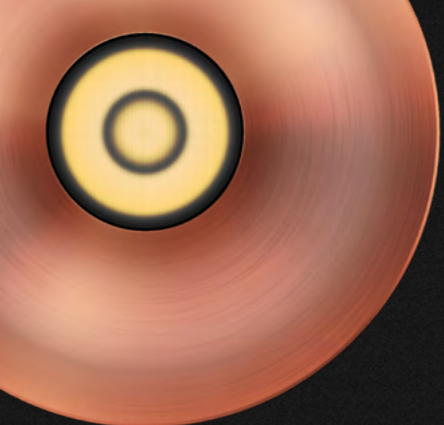

Altera SF.

Surface-mounted luminaire with sleek curved lines, designed for direct ceiling installation, featuring a ceiling cap for secure and seamless mounting. This fixture offers both elegance and functionality, with an adjustable design that allows for precise beam positioning to create the perfect ambiance in any décor. Utilizing the advanced LumiCross Lens technology, it delivers exceptional illumination with minimal glare and maximum visual comfort.

Illumination options CCT 2700K • CRI >98Ra • 800Lm
 CCT 3000K • CRI >98Ra • 850Lm

UGR <18 for 24° • <25 for 36°

LIGHT BEAM ANGLE



FIXTURE OPTIONS



Available Finishes

Standard



Black



White

Premium



Matte brass



Gunmetal



Matte copper

Custom RAL finishes





Pendant luminaires.

Introducing the Pendant luminaires, a perfect fusion of design and function created to elevate any space with its elegant suspended presence. With clean and flowing lines, crafted from premium materials, these luminaires offer a modern aesthetic while providing outstanding illumination quality.

Suspended effortlessly from the ceiling, the Pendant luminaires create a striking visual statement. Whether used to highlight key areas or to provide ambient lighting, this collection combines cutting-edge technology with timeless design, delivering unparalleled visual comfort and performance.



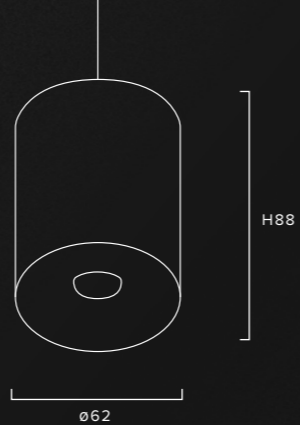
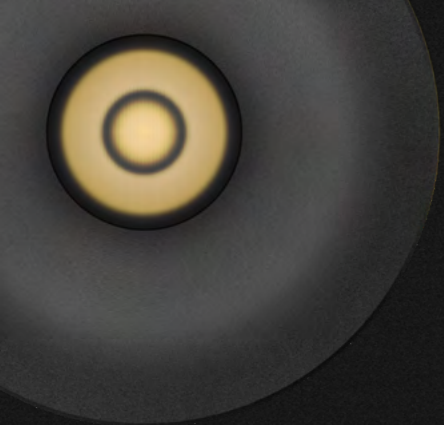

Eterna PD.

Pendant luminaire featuring sleek curved lines, offering elegance and functionality in a compact design. Crafted from a single piece, it incorporates an internal driver and an invisible suspension system for a seamless, floating appearance. Utilizing advanced LumiCross Lens technology, the fixture minimizes glare while delivering exceptional visual comfort.

Illumination options

CCT 2700K • CRI >98Ra • 800Lm
 CCT 3000K • CRI >98Ra • 900Lm

UGR

<12 for 24° • <15 for 36°

LIGHT BEAM ANGLE



FIXTURE OPTIONS



Available Finishes

Standard



Black



White

Premium



Matte brass



Gunmetal



Matte copper

Custom RAL finishes



1019 7006 7033 7009 8002 8012 3009 3020 4004 1021 2001 2008 5020 5015 6009 6029



ELYS - The essence of light



ELYS.

Enlightened by
Lightsale BV

Zandzuigerstraat 81
1333MX Almere
The Netherlands

+31 36 26 000 36
info@lightsale.nl



